



SAFEasy™: safety in your hands

- **Integrated light curtain for HAND PROTECTION (30 mm resolution)**
- **Maximum operating distance reaching 19 m**
- **Controlled heights ranging from 150 to 1800 mm**
- **Compact 32x37 mm profile**
- **Selectable EDM and Manual/Automatic Restart**

SG4-HAND SERIES

The new series of **SAFEasy™ SG4-B HAND** safety light curtains widens the existing **SG** range, whilst representing an evolution of the SE4-PLUS line, offering a Type 4 safety light device for hand protection with base functions. Ideal for applications that do not require complementary functions such as Muting, Cascade and blanking.

The new **SG4-B** series has been especially developed to simplify:

- installation (new rotating TOP-BOTTOM fixing brackets to ease alignment);
- connection (use of standard connectors, no connection between emitter and receiver necessary);
- configuration (no external control units and / or supplementary cables necessary);
- use (alignment guided by a 7 segment double display on both units).

Improved response time and operating distance, respect to the SE4-PLUS series distinguish this series and make it one of the best performing light curtains available today on the market.

The main characteristics of the SG4-B HAND are:

- Operating distance reaching 19 m
- Response times ranging from 9 to 27 msec
- Controlled heights ranging from 150 to 1800 mm
- New sturdy and more functional profile
- Compatibility with the entire SE accessory range
- Selectable EDM and Manual/Automatic Restart
- User interface equipped with a 7 segment display on both TX and RX units
- Alignment aid function

DIMENSIONS

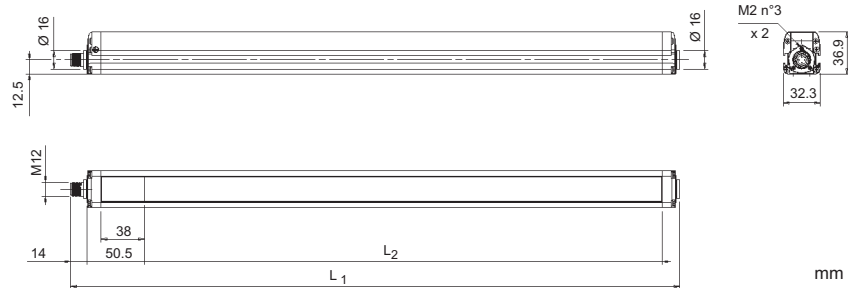

VERSIONS	L ₁	L ₂
SG4-30-015-OO-E	233.3	153.3
SG4-30-030-OO-E	383.2	303.2
SG4-30-045-OO-E	533.2	453.3
SG4-30-060-OO-E	683.2	603.2
SG4-30-075-OO-E	833.2	753.3
SG4-30-090-OO-E	983.2	903.2
SG4-30-105-OO-E	1133.2	1053.2
SG4-30-120-OO-E	1283.3	1203.3
SG4-30-135-OO-E	1433.2	1353.2
SG4-30-150-OO-E	1583.3	1503.3
SG4-30-165-OO-E	1733.3	1653.3
SG4-30-180-OO-E	1883.3	1803.3

INDICATORS AND SETTINGS

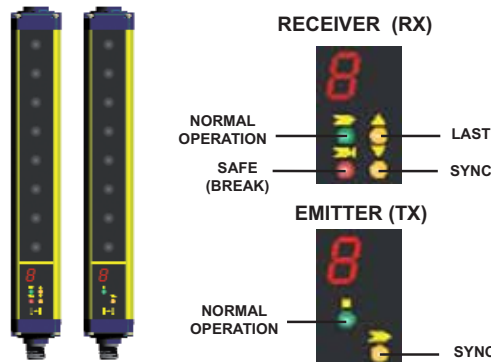

CONNECTIONS

M12 8-POLE CONNECTOR

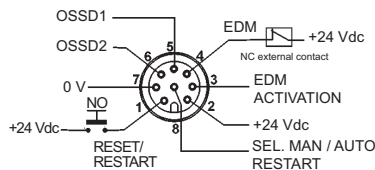

- 1 = white = RESET (*)
- 2 = brown = +24 Vdc
- 3 = green = EDM ACTIVATION (**)
- 4 = yellow = EDM
- 5 = grey = OSSD1
- 6 = pink = OSSD2
- 7 = blue = 0 V
- 8 = red = SEL. MAN. / AUTO RESTART

M12 4-POLE CONNECTOR

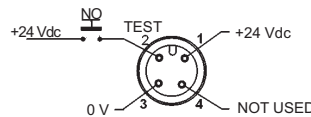

- 1 = brown = +24 Vdc
- 2 = white = TEST
- 3 = blue = 0 V
- 4 = black = NOT USED

* automatic RESTART - RESET function
 manual RESTART - RESET/RESTART function
 ** Refer to "SG4-B: PLUS function"



TECHNICAL DATA

ELECTRICAL DATA

Power supply (Vdd)	24 Vdc \pm 20%
Consumption (TX):	2.5 W max
Consumption (RX):	4 W max (without load)
OSSD outputs:	2 PNP
Short-circuit protection:	1.4 A max
Output current:	0.5 A max on each output
Output voltage – ON status:	Vdd-1 V
Output voltage – OFF status:	0.2 V
Leakage current:	< 1mA
Capacitive load:	2.2 μ F @ 24Vdc (*)
Response time:	Refer to table
Controlled height:	150 ... 1800 mm
Safety category:	Type 4
Auxiliary functions:	Reset/Test Selectable Man./ Auto. Restart Selectable EDM
Electrical protection:	Class I / Class III
Connections:	M12 4-pole for emitter M12 8-pole for receiver
Cable length (for powering)	50 m. max (*)

OPTICAL DATA

Light emission:	Infrared LED (950 nm)
Resolution:	30 mm
Operating distance:	0.2... 19 m
Aperture angle (EAA):	\pm 2.5°
Ambient light rejection:	IEC 61496-2

MECHANICAL AND ENVIRONMENTAL DATA

Operating temperature:	0...55°C
Storage temperature:	-25...+ 70 °C
Temperature class:	T6
Humidity:	15...95 % (non condensating)
Mechanical protection:	IP65 (EN 60529)
Vibrations:	Width 0.35 mm Frequency 10 ... 55 Hz 20 sweep per axis, 1 octave/min (EN 60068-2-6)
Shock resistance:	16 ms (10g) 1.000 shock per axis (EN 60068-2-29)
Housing material:	Painted aluminium (yellow RAL 1003)
Protective shield material:	PMMA
Cap material:	PC MAKROLON
Weight:	1.3 Kg / m

* If a longer cable has to be used, please verify that the capacitive load specifications are respected

TABLES

Model	
SG4 height 150	8
SG4 height 300	16
SG4 height 450	24
SG4 height 600	32
SG4 height 750	40
SG4 height 900	48
SG4 height 1050	56
SG4 height 1200	64
SG4 height 1350	72
SG4 height 1500	80
SG4 height 1650	88
SG4 height 1800	96

Table 1: NUMBER OF CONTROLLED BEAMS

Model	
SG4 height 150	150
SG4 height 300	300
SG4 height 450	450
SG4 height 600	600
SG4 height 750	750
SG4 height 900	900
SG4 height 1050	1050
SG4 height 1200	1200
SG4 height 1350	1350
SG4 height 1500	1500
SG4 height 1650	1650
SG4 height 1800	1800

Table 2: CONTROLLED HEIGHT (mm)

Model	
SG4 height 150	9
SG4 height 300	11
SG4 height 450	13
SG4 height 600	14
SG4 height 750	16
SG4 height 900	18
SG4 height 1050	19
SG4 height 1200	21
SG4 height 1350	23
SG4 height 1500	25
SG4 height 1650	26
SG4 height 1800	28

Table 3: RESPONSE TIME (ms)



NEW FEATURES INTRODUCED

Respect to the SE4-PLUS series, the **SG4-B HAND** light curtains present some new improvements:

■ Increased operating distance

The 19 m operating distance makes the **SG4-B HAND** safety light curtain the ideal device for plants with large dimensions, as well as guaranteeing improved flexibility in applications with deviating mirrors.

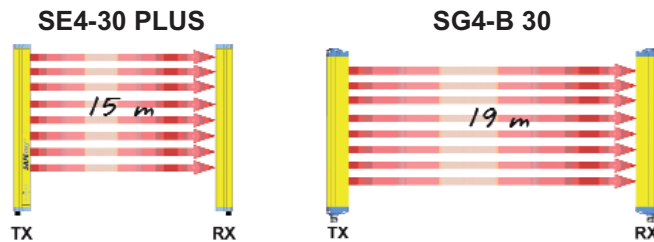

■ Controlled height range extended from 150 to 1800 mm

The controlled height extended to 1800 mm allows **SG4-B HAND** to be used in applications where high areas have to be protected.

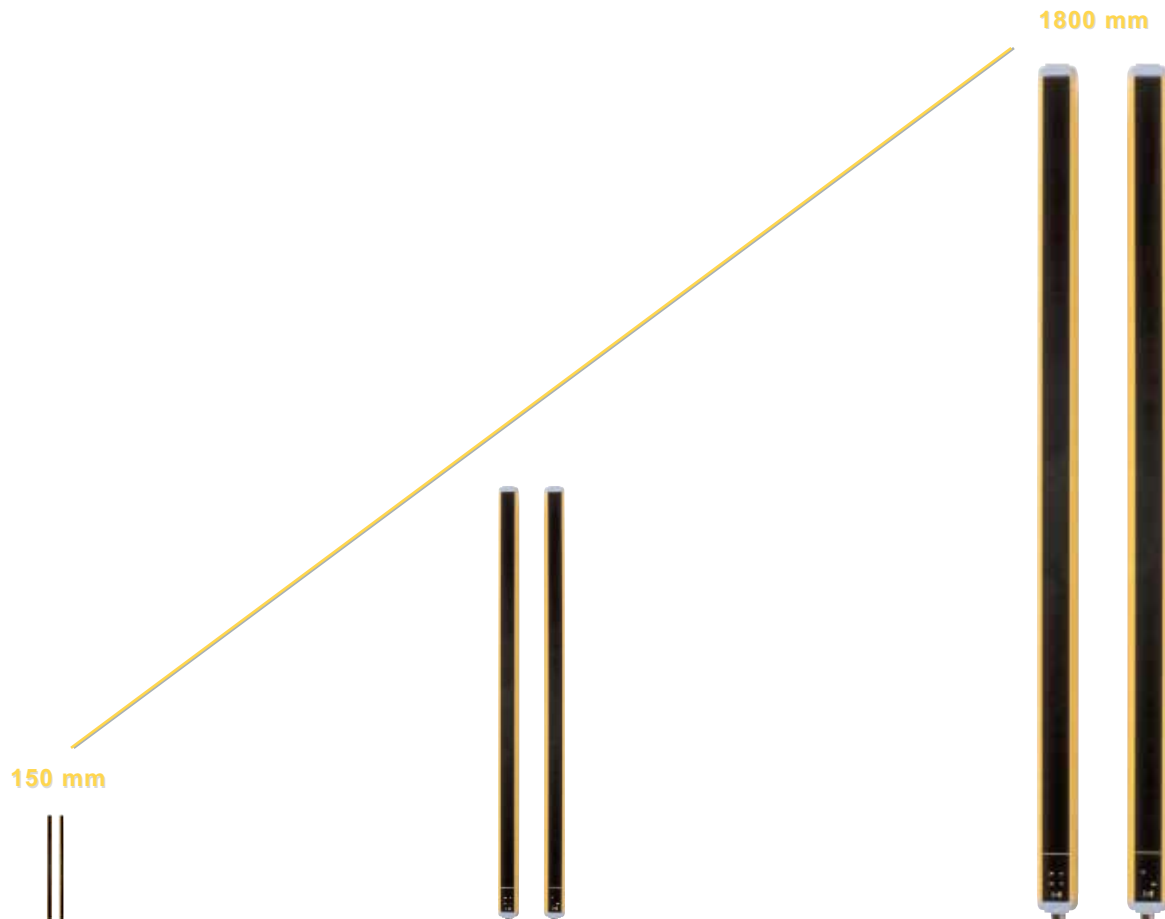

SG4-B: FUNCTIONS

EDM

The **EDM** function allows to connect the light barrier to a couple of simple forced-guided safety relays instead to a Type 4 safety relay and thus guaranteeing an enormous economical advantage.

Connection with EDM function

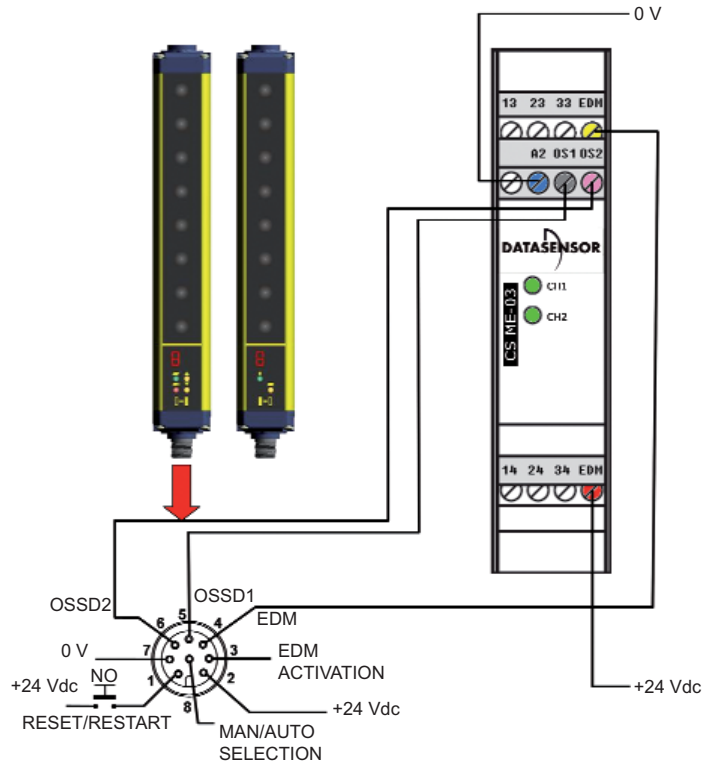

Connection without EDM function

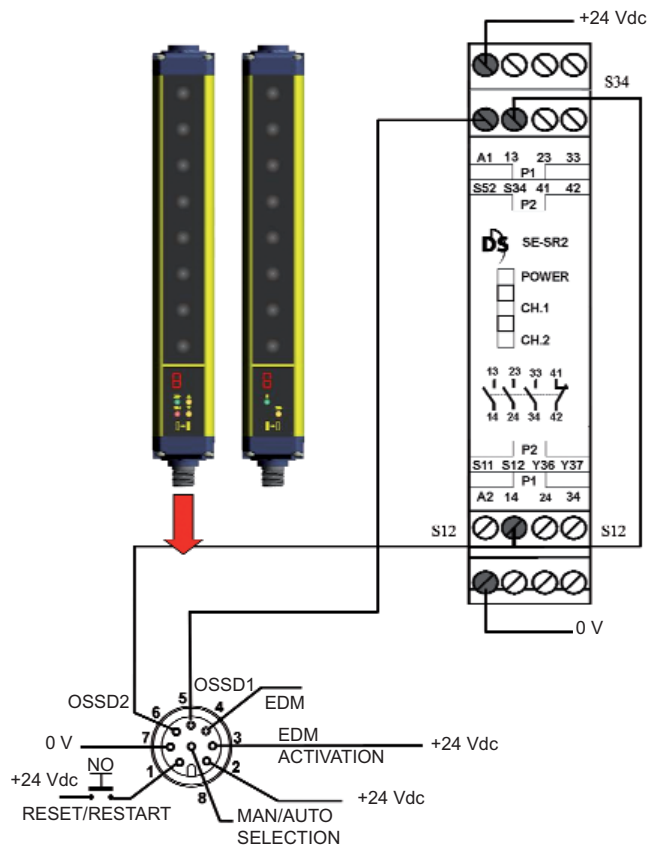

APPLICATIONS

The **SG4-B HAND** safety light curtains provide solutions in all automation fields where the access to dangerous areas has to be controlled.

In particular, the safety curtains can be used in stopping moving parts in:

- Automatic machines;
- Packaging and cutting machines;
- Textile, wood-working and ceramic machines;
- Automatic assembling lines;
- Milling, lathe and shearing machines;
- Bending and metal-working machines.

Example 1: Milling machines

A milling machine is a machine tool used for the shaping of metals and other solid materials. Operator hands and body must be protected from being dragged, entangled or cut by the tool / spindle.

Solution: the **SG4-B HAND** safety light curtain is the best solution considering the required safety levels and application type. When even just one of the light curtain beams is interrupted, the machine is immediately stopped.

Advantages: The extremely reduced profile guarantees installation flexibility adapting itself to the machine dimensions. The rotating fixing brackets, supplied as accessories, speed up and facilitate mounting.

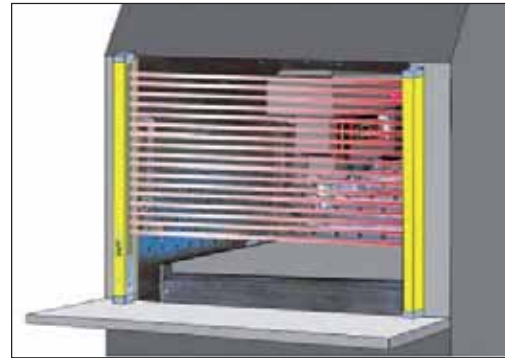

Example 2: Paper cutting machines

These machines typically cut paper to a specific size for newspapers or special applications. The operator must be protected against abrasion or cuts by cutter blades.

Solution: the **SG4-B HAND** safety light curtain is especially suitable for this kind of application, which requires the installation of the device directly on the machine.

Advantages: The extremely reduced profile guarantees installation flexibility adapting itself to the machine dimensions. The rotating fixing brackets, supplied as accessories, speed up and facilitate mounting.

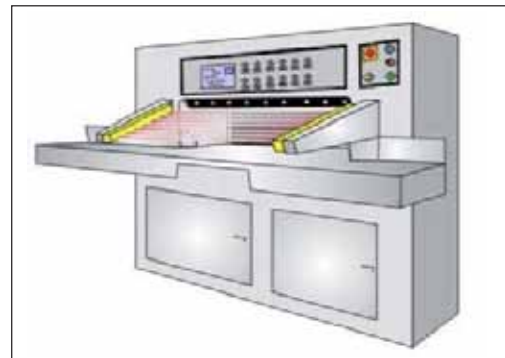

FIXING BRACKETS

Rotating fixing bracket¹

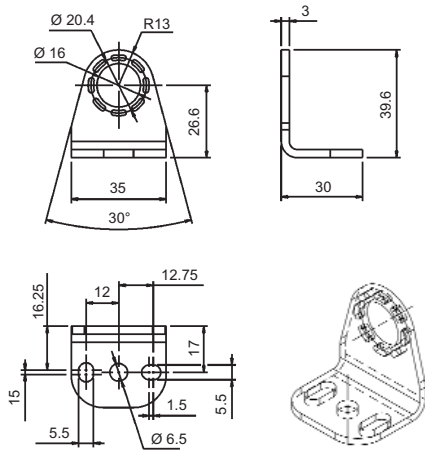

Angled fixing bracket²

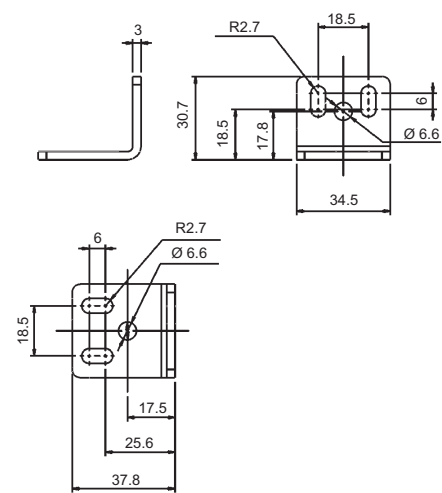

¹ Accessory sold separately

² Supplied in the package

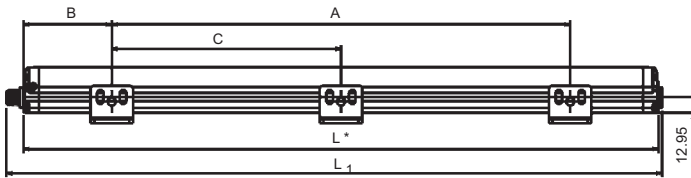
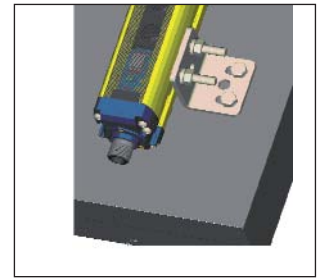
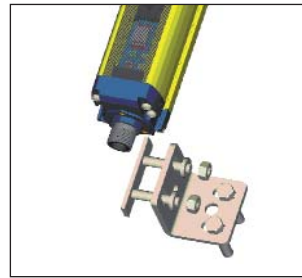
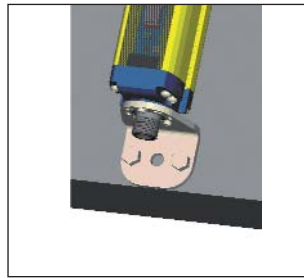

MODELS	L (mm)	A (mm)	B (mm)	C (mm)
SG4-30-015-OO-E	216.3	108	54	-
SG4-30-030-OO-E	366.2	216	75	-
SG4-30-045-OO-E	516.3	316	100	-
SG4-30-060-OO-E	666.2	366	150	-
SG4-30-075-OO-E	816.3	466	175	-
SG4-30-090-OO-E	966.2	566	200	-
SG4-30-105-OO-E	1116.2	666	225	-
SG4-30-120-OO-E	1266.3	966	150	483
SG4-30-135-OO-E	1416.2	1066	175	533
SG4-30-150-OO-E	1566.3	1166	200	583
SG4-30-165-OO-E	1716.3	1266	225	633
SG4-30-180-OO-E	1866.3	1366	250	683

Installation with anti-vibration supports

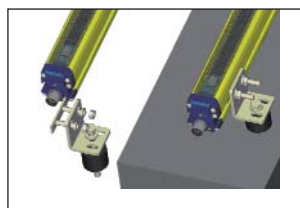
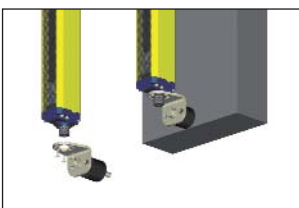

MODEL SELECTION AND ORDER INFORMATION

MODEL	DESCRIPTION	ORDER N°
SG4-30-015-OO-E	Type 4 safety light curtain h=150 mm	957901120
SG4-30-030-OO-E	Type 4 safety light curtain h=300 mm	957901130
SG4-30-045-OO-E	Type 4 safety light curtain h=450 mm	957901140
SG4-30-060-OO-E	Type 4 safety light curtain h=600 mm	957901150
SG4-30-075-OO-E	Type 4 safety light curtain h=750 mm	957901160
SG4-30-090-OO-E	Type 4 safety light curtain h=900 mm	957901170
SG4-30-105-OO-E	Type 4 safety light curtain h=1050 mm	957901180
SG4-30-120-OO-E	Type 4 safety light curtain h=1200 mm	957901190
SG4-30-135-OO-E	Type 4 safety light curtain h=1350 mm	957901200
SG4-30-150-OO-E	Type 4 safety light curtain h=1500 mm	957901210
SG4-30-165-OO-E	Type 4 safety light curtain h=1650 mm	957901220
SG4-30-180-OO-E	Type 4 safety light curtain h=1800 mm	957901230

ACCESSORYSELECTION AND ORDER INFORMATION

MODEL	DESCRIPTION	ORDER N°
CS-A1-02-U-03	M12 4-pole unshielded axial 3 m connector, UL 2464	95ASE1120
CS-A1-02-U-05	M12 4-pole unshielded axial 5 m connector, UL 2464	95ASE1130
CS-A1-02-U-10	M12 4-pole unshielded axial 10 m connector, UL 2464	95ASE1140
CS-A1-02-U-15	M12 4-pole unshielded axial 15 m connector, UL 2464	95ASE1150
CS-A1-02-U-25	M12 4-pole unshielded axial 25 m connector, UL 2464	95ASE1160
CS-A1-06-U-03	M12 8-pole unshielded axial 3 m connector, UL 2464	95ASE1220
CS-A1-06-U-05	M12 8-pole unshielded axial 5 m connector, UL 2464	95ASE1230
CS-A1-06-U-10	M12 8-pole unshielded axial 10 m connector, UL 2464	95ASE1240
CS-A1-06-U-15	M12 8-pole unshielded axial 15 m connector, UL 2464	95ASE1250
CS-A1-06-U-25	M12 8-pole unshielded axial 25 m connector, UL 2464	95ASE1260
ST-KSTD	Angled fixing brackets (4 pc kit)	95ACC1670
ST-K4AV	Anti-vibration supports (4 pc kit)	95ACC1700
ST-K6AV	Anti-vibration supports (6 pc kit)	95ACC1710
ST-K4ROT	Top-Bottom rotating fixing brackets (4 pc kit)	95ASE1280

Please refer also to **Safety Device Accessories**

SAFETY DEVICES



Distributed by:



www.asi-ez.com

877-650-5160

PO BOX 1340, Mechanicsburg PA 17055