

Morsetti per C.S. carrello

Terminal blocks for P.C.B. rising clamp

Blocs de jonction C.I. étrier remontant

Printklemme liftprinzip

MRT18..V04



Modulo componibile Interlocking modules
Elements modulaires Zusammensteckbare Blöcke





2/3 Poli 2/3 Poles
2/3 Pôles 2/3 Polzahl



Passo <i>Pas</i>	Pitch <i>Rastermaß</i>	mm
Tensione nominale <i>Tension nominale</i>	Rated Voltage <i>Bemessungsspannung</i>	V
Corrente nominale <i>Intensité nominale</i>	Rated Current <i>Bemessungsstrom</i>	A

Tipo cavi <i>Type du conducteur</i>	Types of cable <i>Leitungstypen</i>	
Sezione nominale <i>Section nominale</i>	Nominal cross section <i>Nennquerschnitt</i>	mm ² AWG



Lunghezza spelatura <i>Longueur de dénudage</i>	Stripping length <i>Abisolierlänge</i>	mm
Coppia di torsione <i>Couple de serrage</i>	Torque <i>Drehmoment</i>	Nm Lb-in
Temperatura <i>Température</i>	Temperature <i>Temperatur</i>	°C
Corpo isolante <i>Corps isolant</i>	Housing <i>Isolierkörper</i>	
Vite imperdibile <i>Vis imperdibile</i>	Captive screw <i>Unverlierbare Schraube</i>	
		mm

   	IMQ	EN60998
	VDE	EN60998
	UL	UL1059
	cUL	UL1059 + C22.2 n°158

Poli <i>Pôles</i>	Poles <i>Polzahl</i>	X ▶
Colori <i>Couleurs</i>	Colors <i>Farben</i>	Y ▶
Ordinazione <i>Référence de commande</i>	How to order <i>Bestellschlüssel</i>	



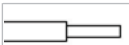
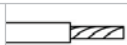



Altri dati <i>Autres données</i>	Other information <i>Weitere Informationen</i>	pag. seite
--	---	---------------

5,08
320
20

		
0,2 ÷ 4 30 ÷ 12	0,2 ÷ 2,5 30 ÷ 12	0,2 ÷ 2,5 30 ÷ 12

6
0,5 / 5
110
PA - UL 94 V0
M3
 0,6x3,5

V	A	mm ² /AWG
450	20	0,5 ÷ 2,5
450	20	0,5 ÷ 2,5
300	20	30 ÷ 12

min 2 - max ...					
					
MRT18 P5,08 / X V04 Y					

127

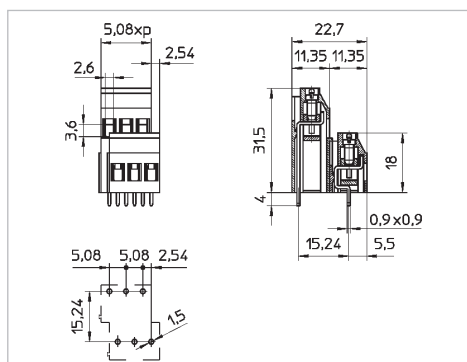

MRT18..V05





Modulo componibile Interlocking modules
Elements modulaires Zusammensteckbare Blöcke

2/3 Poli 2/3 Poles
2/3 Pôles 2/3 Polzahl



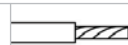





5,08
320
20

		
0,2 ÷ 4 30 ÷ 12	0,2 ÷ 2,5 30 ÷ 12	0,2 ÷ 2,5 30 ÷ 12

6
0,5 / 5
110
PA - UL 94 V0
M3
 0,6x3,5

V	A	mm ² /AWG
450	20	0,5 ÷ 2,5
450	20	0,5 ÷ 2,5
300	20	30 ÷ 12

min 2 - max ...					
					
MRT18 P5,08 / X V05 Y					

127

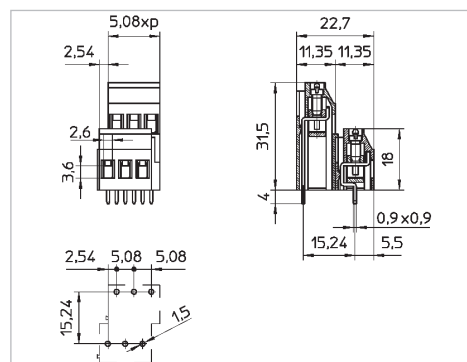

To locate additional product specifications and technical drawings go to www.asi-ez.com