



- *3 channel colour sensor with C or C+I functions and 10 tolerance levels*
- *Wide spectrum white light LED emission and RGB photoreceiver*
- *3 independent NPN or PNP outputs and RS485 serial interface*
- *2 push-button easy setting and 4 digit display*

## S65-V SERIES

The **S65-V** colour sensors offer the best performances for colour detection in a standard 50x50x25 mm compact housing.

The **S65-V0** model, thanks to a good response time of only 340  $\mu$ s, results to be particularly suitable for automatic packaging applications where high speed and colour mark detection are necessary. The **S65-V1** model increases the chromatic sensitivity of **S65-V0** towards dark colours, allowing to distinguish even slight tone differences, useful in quality control and part checking, at inferior process speed.

The sensors can memorise and recognise 3 colours on 3 independent channels. The C (chromaticity) or C+I (chromaticity and intensity) detection algorithm and the tolerance level can be chosen for each colour. The 0 - 40 ms delay programming is the same for each channel.

The auxiliary functions include keylock and synchronisation with external events through a specific input. The control panel presents two setting push-buttons, outputs LEDs and a 4-digit display for functioning messages and sensor configuration. Complete remote control is possible for the version with the RS485 serial interface, which in the **S65-V1** sensor can also receive RGB chromatic information.

# V COLOUR SENSORS

The colour sensor can be configured in a 'C' or 'C+I' detection mode. The 'C' type algorithm is used to obtain a larger depth of field, or to detect colours on different opaque, shiny or reflecting surfaces. The 'C+I' type algorithm offers a higher sensitivity towards tone variations, and is recommended for the detection of different colours on the same type of material. It will also distinguish grey tones.



## DIMENSIONS

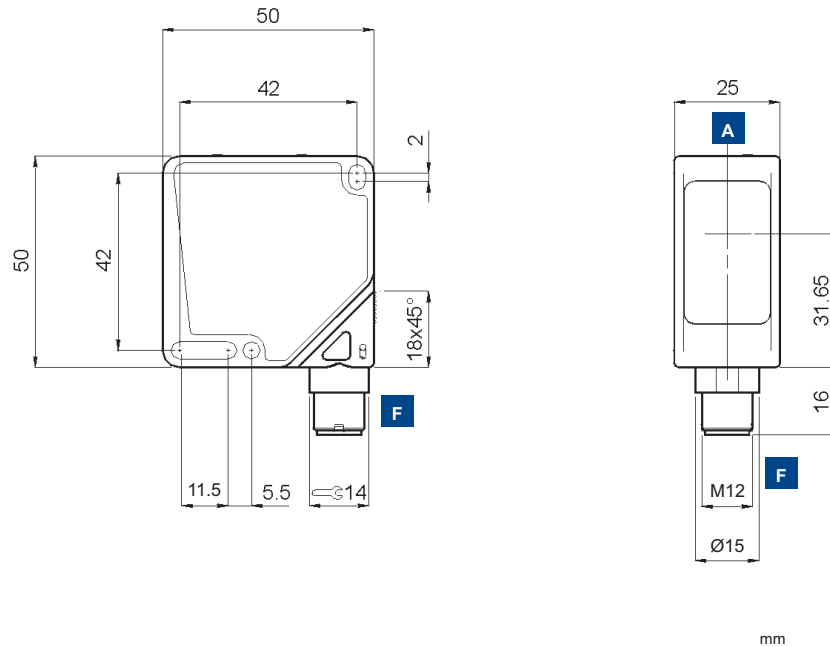

## INDICATORS AND SETTINGS

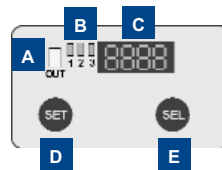

- A** Output 'OR' function LED
- B** Output status LEDs
- C** 4 digit display
- D** SET push-button
- E** SEL push-button
- F** M12 connector output, orientable on two positions

## ACCESSORIES

For dedicated accessories refer to the ACCESSORIES section of this catalogue.

Refer also to Connectors (A.03) and Fixing Brackets (A.04) of the General Catalogue.

## CONNECTIONS



S65-PA-5

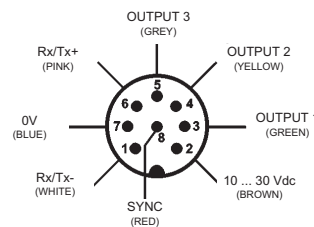

## TECHNICAL DATA

		S65-PA-5-V09-NNN	S65-PA-5-V09-NNNZ	S65-PA-5-V09-PPP	S65-PA-5-V09-PPZ	S65-PA-5-V19-NNN	S65-PA-5-V19-NNNZ	S65-PA-5-V19-PPP	S65-PA-5-V19-PPZ
<b>Operating distance:</b>	5 ... 45 mm *	●	●	●	●	●	●	●	●
<b>Power supply:</b>	10 ... 30 Vdc <sup>1</sup>	●	●	●	●	●	●	●	●
<b>Ripple:</b>	2 Vpp	●	●	●	●	●	●	●	●
<b>Consumption:</b>	60 mA at 24 V	●	●	●	●	●	●	●	●
<b>Light emission:</b>	white LED 400 -700 nm <sup>2</sup>	●	●	●	●	●	●	●	●
<b>Spot dimension:</b>	approx. 4 mm at 20 mm	●	●	●	●	●	●	●	●
<b>Setting:</b>									
	SET push-button	●	●	●	●	●	●	●	●
	SEL push-button	●	●	●	●	●	●	●	●
<b>Indicators:</b>									
	4 digit display	●	●	●	●	●	●	●	●
	green active OUTPUT LEDs	●	●	●	●	●	●	●	●
	yellow 'OR' function OUTPUT LED	●	●	●	●	●	●	●	●
<b>Output type:</b>									
	PNP - NO			●				●	
	NPN - NO	●	●			●	●		
<b>Output current:</b>	≤ 100 mA	●	●	●	●	●	●	●	●
<b>Saturation voltage:</b>	≤ 2 V	●	●	●	●	●	●	●	●
<b>Response time:</b>									
	335 μs	●	●	●					
	1 ms (FAST); 5 ms (NORM)					●	●	●	●
<b>Switching frequency:</b>									
	1.5 kHz	●	●	●					
	500 Hz (FAST); 100 Hz (NORM)					●	●	●	●
<b>Operating mode:</b>	C or C+I independent for each channel	●	●	●	●	●	●	●	●
<b>Tolerance level:</b>	selectable from TOL0 to TOL9	●	●	●	●	●	●	●	●
<b>Timing function:</b>	selectable between 5, 10, 20, 30 and 40 ms	●	●	●	●	●	●	●	●
<b>Auxiliary functions:</b>									
	ext. synchronism	●	●	●	●	●	●	●	●
	keylock <sup>3</sup>	●	●	●	●	●	●	●	●
	RS485 serial interface		●	●	●		●	●	
<b>Connection:</b>	M12 8-pole connector <sup>4</sup>	●	●	●	●	●	●	●	●
<b>Electrical protection:</b>	class 2	●	●	●	●	●	●	●	●
<b>Mechanical protection:</b>	IP67	●	●	●	●	●	●	●	●
<b>Protection devices:</b>	A, B <sup>5</sup>	●	●	●	●	●	●	●	●
<b>Housing material:</b>	ABS	●	●	●	●	●	●	●	●
<b>Lens material:</b>	glass	●	●	●	●	●	●	●	●
<b>Weight:</b>	100 g max.	●	●	●	●	●	●	●	●
<b>Operating temperature:</b>	-10 ... +55°C	●	●	●	●	●	●	●	●
<b>Storage temperature:</b>	-25 ... +70°C	●	●	●	●	●	●	●	●
<b>Reference standard:</b>	EN 60947-5-2	●	●	●	●	●	●	●	●

\* refer to detection diagrams

## SELECTION TABLE

colour sensors			
S65-PA-5-V09-NNN	956251030	NPN	
S65-PA-5-V09-NNNZ	956251010	NPN	RS485
S65-PA-5-V09-PPP	956251020	PNP	
S65-PA-5-V09-PPZ	956251000	PNP	RS485
S65-PA-5-V19-NNN	956251110	NPN	
S65-PA-5-V19-NNNZ	956251090	NPN	RS485
S65-PA-5-V19-PPP	956251100	PNP	
S65-PA-5-V19-PPZ	956251080	PNP	RS485

## TECHNICAL NOTES

- Limit values
- Average life of 100.000 h with  $T_A = +25^\circ\text{C}$
- Is activated with SYNC connected to +V at powering
- Connector can be blocked on two positions
- A - reverse polarity protection  
B - overload and short-circuit protection



## DETECTION DIAGRAMS

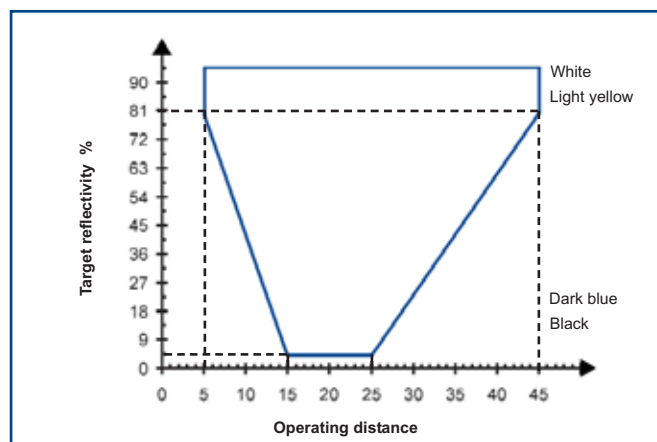
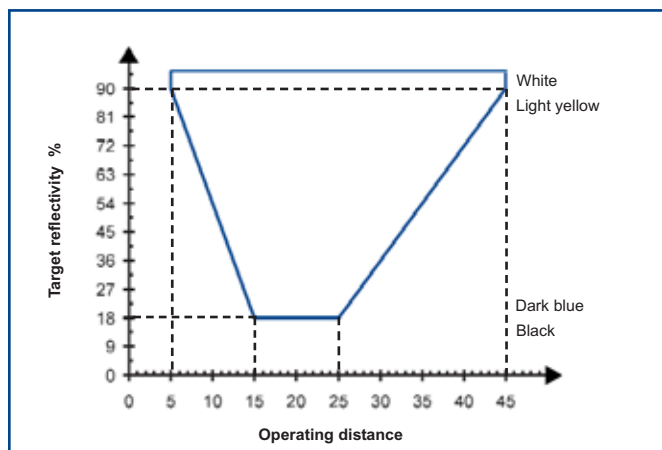

## MODEL SELECTION AND ORDER INFORMATION

MODEL	FUNCTION	CONNECTION	OUTPUT	RS485	ORDER N°
S65-PA-5-V09-NNN	colour sensor	M12 connector	NPN		956251030
S65-PA-5-V09-NNNZ	colour sensor	M12 connector	NPN	•	956251010
S65-PA-5-V09-PPP	colour sensor	M12 connector	PNP		956251020
S65-PA-5-V09-PPPZ	colour sensor	M12 connector	PNP	•	956251000
S65-PA-5-V19-NNN	colour sensor	M12 connector	NPN		956251110
S65-PA-5-V19-NNNZ	colour sensor	M12 connector	NPN	•	956251090
S65-PA-5-V19-PPP	colour sensor	M12 connector	PNP		956251100
S65-PA-5-V19-PPPZ	colour sensor	M12 connector	PNP	•	956251080

## ACCESSORIES

## DIMENSIONS

ST-5020

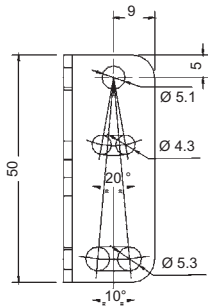
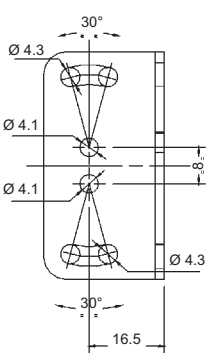
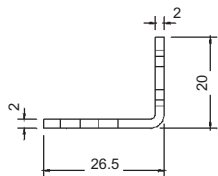

ST-5021

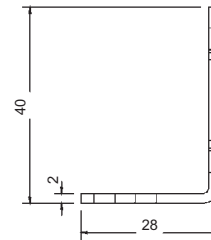
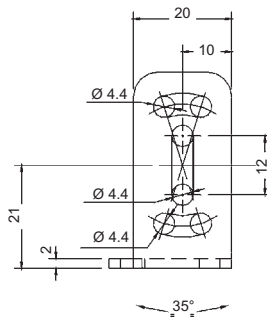
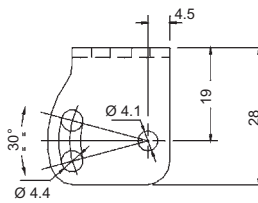

## ACCESSORY SELECTION AND ORDER INFORMATION

MODEL	DESCRIPTION	N° ORDER
ST-5020	fixing bracket 50 x 27 x 20 mm	95ACC5330
ST-5021	fixing bracket 20 x 40 x 28 mm	95ACC5340
<i>Refer also to Accessories for Sensors of the General Catalogue</i>		
CS-A1-06-B-03	M12 8-pole conn. with 3 m unshielded cable	95ACC2230
CS-A1-06-B-05	M12 8-pole conn. with 5 m unshielded cable	95ACC2240
CS-A1-06-B-10	M12 8-pole conn. with 10 m unshielded cable	95ACC2250



www.asi-ez.com  
 877-650-5160  
 PO BOX 1340, Mechanicsburg PA 17055

COLOUR SENSORS